

① TOP SLAB VENT PIPE DETAIL

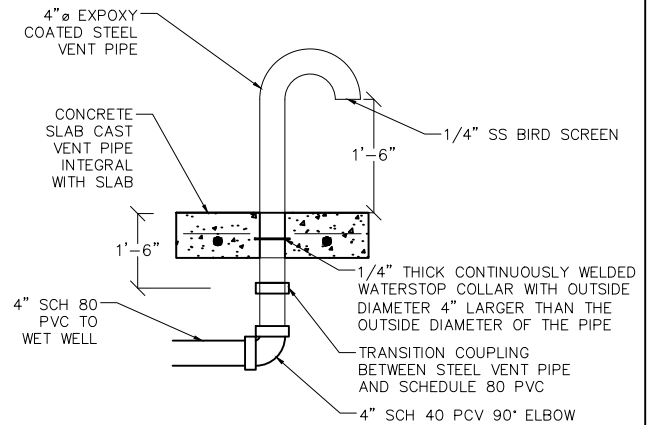

② EXTERIOR VENT PIPE DETAIL

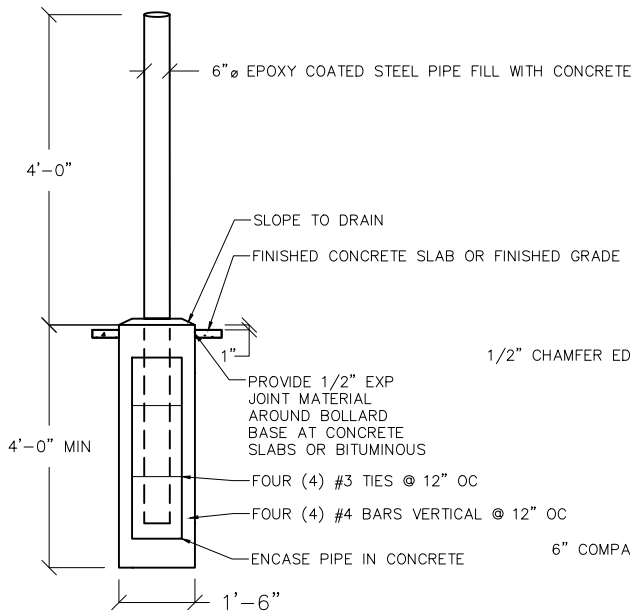

③ BOLLARD DETAIL

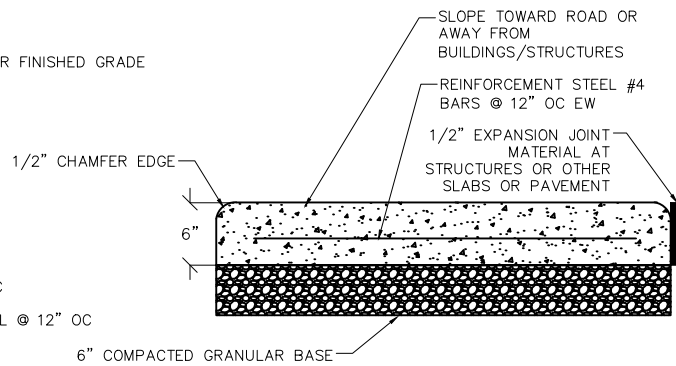

④ CONCRETE SLAB DETAIL

- NOTES
1. PROVIDE TRANSVERSE BROOM FINISH
  2. PROVIDE CONTROL JOINTS AS NECESSARY OR AS DIRECTED BY THE ENGINEER
  3. PROVIDE EXP JOINT MATERIAL AS NECESSARY



STANDARD LIFT  
STATION DETAILS

PLATE NO. LV-SS-14B

DATE 02/2024